

## Notice of Organizational Changes, Personnel Changes

2024/2/2

Toyota Tsusho Corporation (head office: Nagoya City; President & CEO: Ichiro Kashitani) announces the following changes to organizational, and personnel changes effective April 1, 2024.

### I. Organizational changes

1. Organizational changes of business divisions (As of April 1)
2. Organizational changes of SBU (SBU : Strategic Business Unit) (As of April 1)
3. Department changes (As of April 1)

### II. Personnel changes

1. Senior Executive Officers (as of April 1)
2. Executive Officers (as of April 1)
3. Retiring Senior Executive Officers/Executive Officers (on March 31)
4. General Managers et al. (as of April 1)

### III. Execution System (Senior Executive Officers) (As of April 1)

## I. Organizational Changes

The Toyota Tsusho Group, along with accelerating innovation that creates new forms of added value and establishing business domains that are unique to Toyota Tsusho, is aiming to achieve carbon neutrality and a circular economy through group-wide efforts under the slogan: “Passing on a better global environment to the children of the future”.

In April 2023, we reorganized the business domains in which we have strengths, as well as our engagements in the areas of carbon neutrality and the circular economy, into seven priority domains\*. To further accelerate the realization of our growth strategy in those seven priority domains, we are now changing our organizational structure.

Also, we will reevaluate the value we provide to our customers and change the names of our divisions, which have been conventionally based on the products they handled, to ones that express the value the divisions provide to society and our customers based on a clear mission.



\* Seven Priority Domains: Next Mobility, Renewable Energy & Energy Management, Africa, Circular Economy, Batteries, Hydrogen & Alternative Fuels, Economy of Life (Healthcare, foodstuffs, and other businesses that are essential to daily life that enhance the quality of life)

## 1. Organizational changes of business divisions (As of April 1)

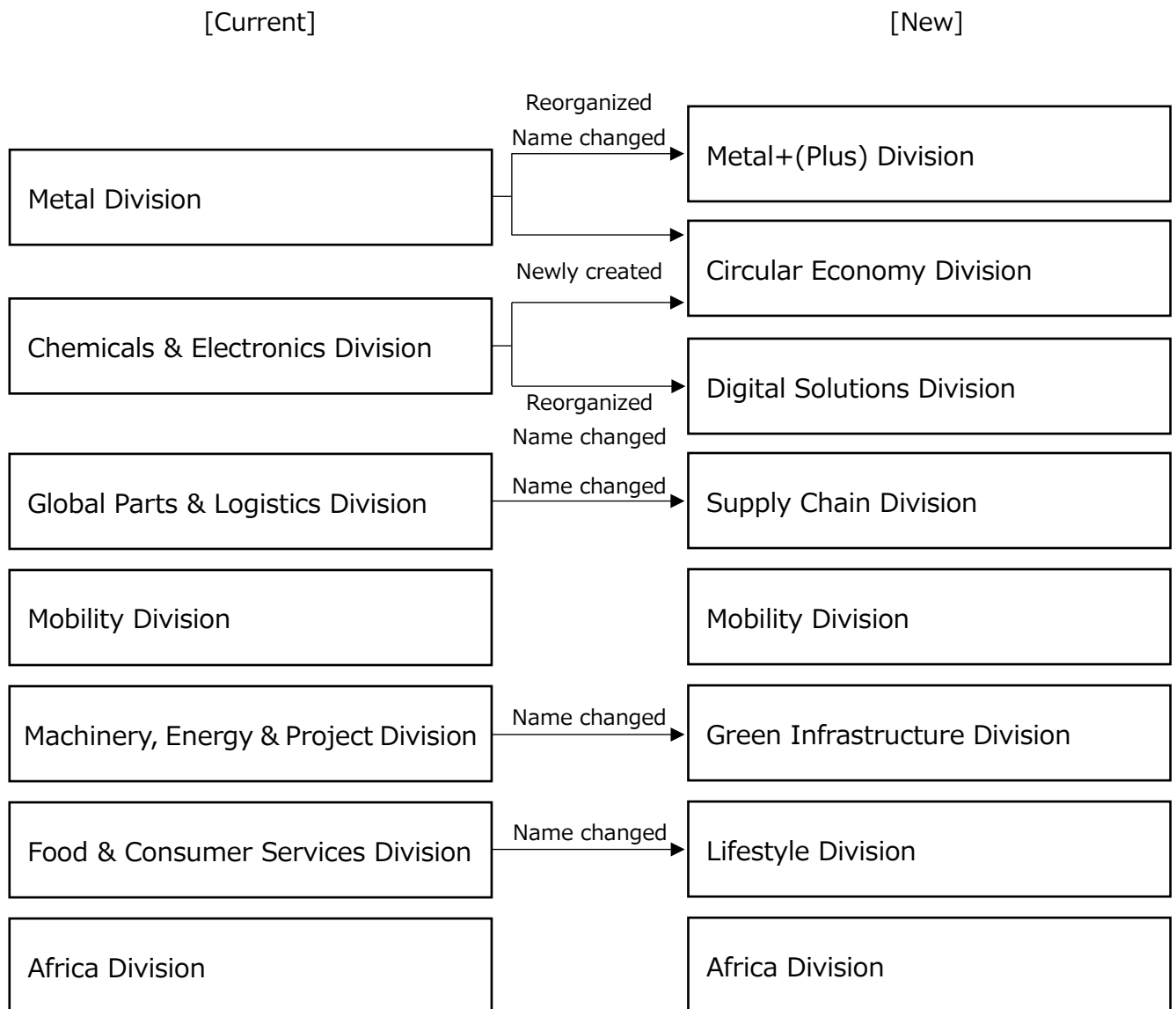

## 2. Organizational changes of SBU (SBU : Strategic Business Unit) (As of April 1)

### (1) Metal+(Plus) Division

Reorganized / Name changed

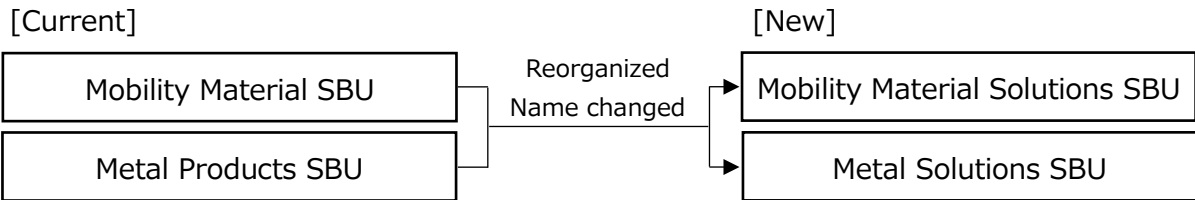

### (2) Circular Economy Division

Reorganized / Newly created

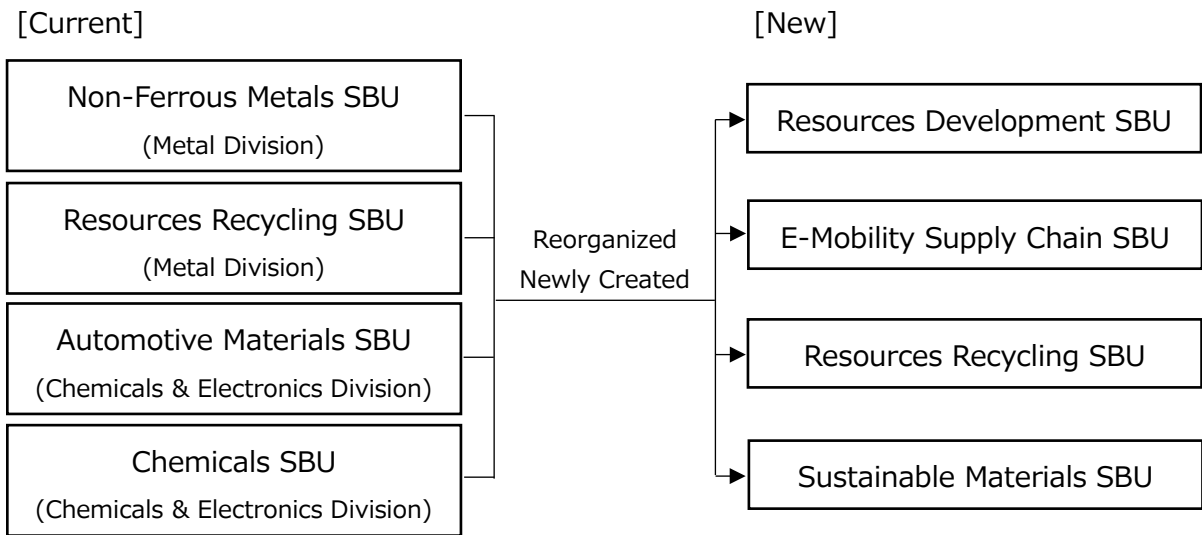

### (3) Supply Chain Division

Name changed

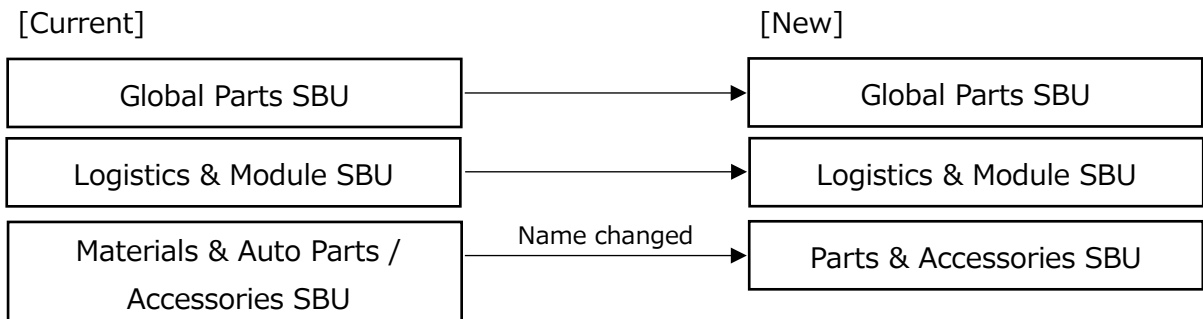

## (4) Mobility Division

No change

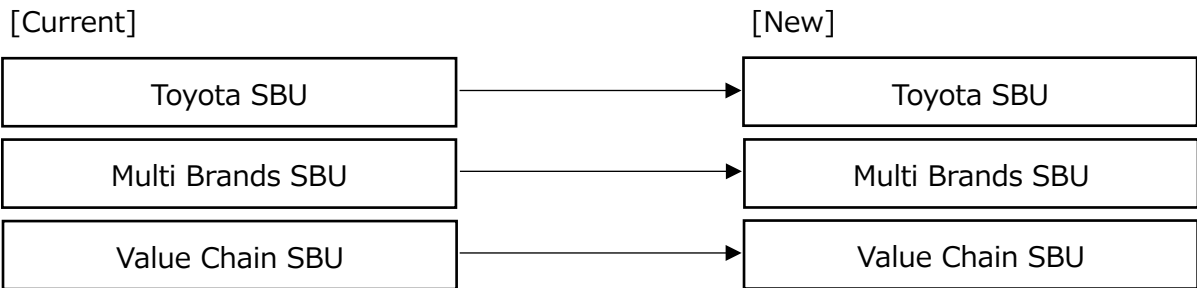

## (5) Green Infrastructure Division

Reorganized / Name changed

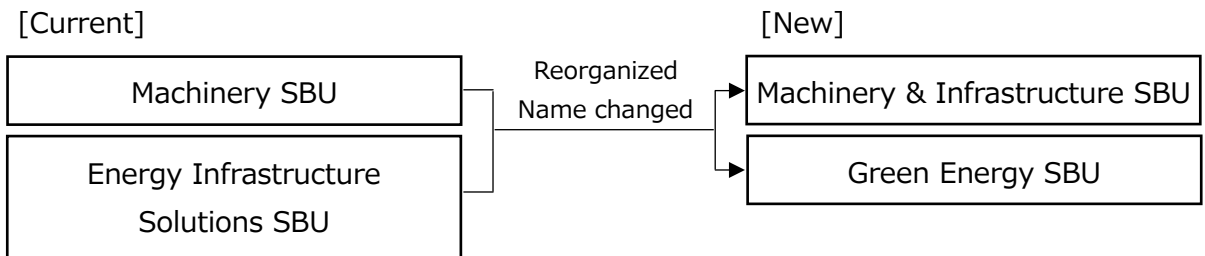

## (6) Digital Solutions Division

Reorganized / Name changed

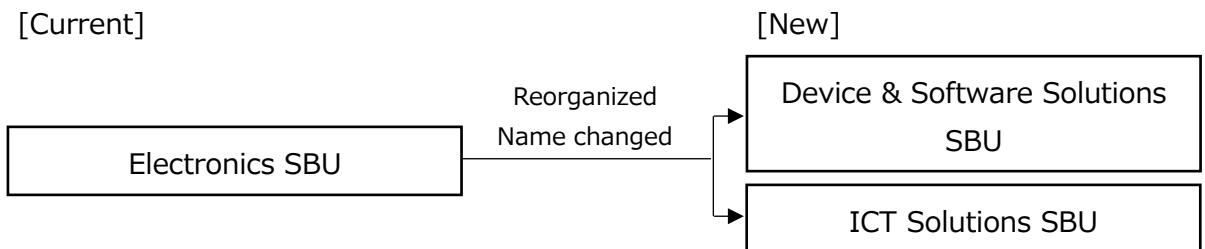

## (7) Lifestyle Division

Name changed

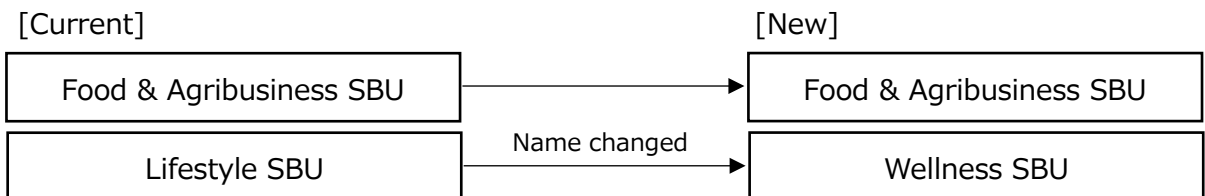

## (8) Africa Division

No change

[Current]

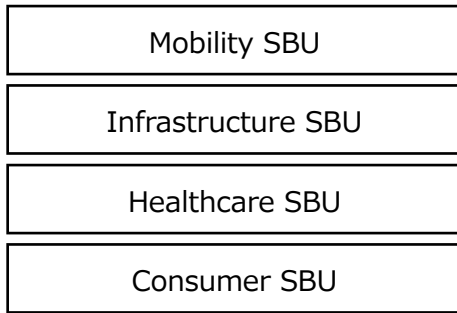

[New]

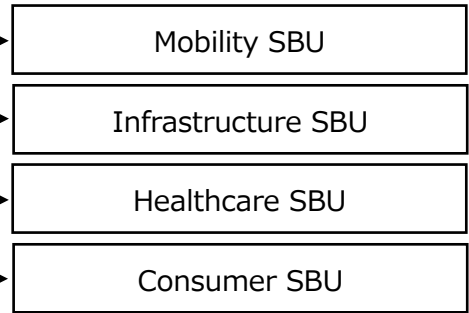

### 3. Department changes (As of April 1)

New departments, reorganized departments & name changes (shows changes only)

#### (1) Metal+(Plus) Division

Current SBU	Current Department Name	New SBU	New Department Name	Change
—	Metal Planning Department	—	Metal+(Plus) Planning Department	Reorganized/ Name changed
Mobility Material SBU	Mobility Material·GX Business Department	Mobility Material Solutions SBU	Mobility Material Business Department	Reorganized/ Name changed
	East-Japan Steel Products Department			
	West-Japan Steel Products Department			
	Mobility Material·GX Global Business Department		Mobility Material Global Business Department	Name changed
	Business Transformation Acceleration Department		Mobility Material Business Management Department	Name changed
Metal Products SBU	Bar, Wire Rod & Pipe Products Department	Metal Solutions SBU	Bar, Wire Rod & Pipe Products Business Department	Reorganized/ Name changed
	East-Japan Steel Products Department		Steel Products Supply Chain Business Department	Name changed
	Steel Products Sales Department		West-Japan Bar, Wire Rod & Pipe Products Business Department	Reorganized/ Name changed
	West-Japan Steel Products Department			

#### (2) Circular Economy Division

Current SBU	Current Department Name	New SBU	New Department Name	Change
—	Metal Planning Department	—	Circular Economy Planning Department	Reorganized/ Name changed
	Chemicals & Electronics Planning Department			
Non-Ferrous Metals SBU	Resources Development Department	Resources Development SBU	Metal Resources Department	Reorganized/ Name changed
Chemicals SBU	Inorganic Chemicals Department		Mineral Resources & Inorganic Chemicals Department	Reorganized/ Name changed
Non-Ferrous Metals SBU	Non-Ferrous Metals Business Department	E-Mobility Supply Chain SBU	Non-Ferrous Metals Business Department	Reorganized
Automotive Materials SBU	Next Mobility Chemical Materials Department		Battery Supply Chain Business Department	Reorganized/ Name changed

Current SBU	Current Department Name	New SBU	New Department Name	Change
Resources Recycling SBU	Circular Economy Business Acceleration Department	Resources Recycling SBU	Reverse Supply Chain Business Department	Reorganized/ Name changed
	Non-Ferrous Material Recycling Business Department		Aluminum Supply Chain Business Department	Reorganized/ Name changed
Automotive Materials SBU	Global Automotive Materials Department		High Performance Materials Department	High Performance Materials Department
	Automotive Materials Project Development Department			
Chemicals SBU	Sustainable Feedstocks and Plastics Department	Sustainable Materials SBU	Sustainable Plastics Department	Reorganized/ Name changed
	Industrial Chemicals Department		Consumer Products Business Department	Reorganized/ Name changed
	Organic Chemicals・Strategy & Management Department		Essential Chemicals Department	Reorganized/ Name changed

### (3) Supply Chain Division

Current SBU	Current Department Name	New SBU	New Department Name	Change
—	Global Parts & Logistics Planning Department	—	Supply Chain Planning Department	Name changed
	SCM Functional Department		Supply Chain DX Department	Reorganized/ Name changed
Global Parts SBU	Global Parts Sales Department	Global Parts SBU	Global Parts Sales Department	
	Eastern Japan Global Parts Department		Global Parts Business Strategy Department	
	Global Parts Business Management Department		Supply Chain Function Development Department	
	Global Parts America & Europe Regional Department		Business Alliance Department	Reorganized/ Newly created
	Global Parts Asia, Oceania & East Asia Regional Department		Global Parts Export Department	Reorganized/ Name changed
Materials & Auto Parts / Accessories SBU	Mobility Service & Accessories Department	Parts & Accessories SBU	Services & Accessories Department	Name changed
	Functional Materials & Safety Business Department		Function Parts & Eco Solutions Business Department	Name changed



## (4) Mobility Division

Current SBU	Current Department Name	New SBU	New Department Name	Change
Multi Brands SBU	Material Handling Machinery Department	Multi Brands SBU	Logistics Solutions Department	Name changed
	Commercial Vehicle Business Department		Commercial Mobility Business Department	Name changed
	Motor Brands Development Department		Multi Brands Business Department	Name changed

## (5) Green Infrastructure Division

Current SBU	Current Department Name	New SBU	New Department Name	Change
—	Machinery, Energy & Project Planning Department	—	Green Infrastructure Planning Department	Name changed
Machinery SBU	Power & Drive Train Machinery Department	Machinery & Infrastructure SBU	Powertrain Machinery Department	Reorganized/ Name changed
	Battery & Environment Machinery Department		EV Component Machinery Department	
	Automotive Body Machinery Department		Automotive Body Machinery Department	
	Industrial Machinery & Technology Department		Infrastructure Project Department	Reorganized/ Name changed
Energy Infrastructure SBU	Energy Infrastructure Project Department	Green Energy SBU	Renewable Energy Strategy Department	Reorganized/ Name changed
	Power Project Development Department			
	Power Project Planning and Asset Management Department			
Machinery SBU	Energy Solutions Development Department			
	Battery & Environment Machinery Department			

## (6) Digital Solutions Division

Current SBU	Current Department Name	New SBU	New Department Name	Change
Electronics SBU	Electronics Department	—	Digital Solutions Planning Department	Reorganized/ Name changed
	—	Device & Software Solutions SBU	Device Business Management Department	Newly created
	Software First Department		Software Defined Vehicle Department	Reorganized/ Name changed
			Advanced Mobility Service Department	Reorganized/ Name changed
	Smart Society Business Development Department	ICT Solutions SBU	Enterprise IT Department	Reorganized/ Name changed
	Information Technology Business Department		Digital Infrastructure Department	Reorganized/ Name changed

## (7) Lifestyle Division

Current SBU	Current Department Name	New SBU	New Department Name	Change
—	Food & Consumer Services Planning Department	—	Lifestyle Planning Department	Name changed
Food & Agribusiness SBU	Osaka Food and Agribusiness Department	Food & Agribusiness SBU	West-Japan Food & Agribusiness Department	Name changed
	Food Marketing Department		Food Solutions Department	Name changed
Lifestyle SBU	Textile Department	Wellness SBU	Sustainable Fashion Department	Name changed
	Living Environment & Real Estate Department		Facility Solutions Department	Name changed
	Insurance Department		Insurance Management Department	Name changed

## (8) Africa Division

Current SBU	Current Department Name	New SBU	New Department Name	Change
—	Africa Planning Department	Infrastructure SBU	Africa Power & Infrastructure Department	Reorganized/ Newly created

## (9) Administrative Unit

Current SBU	Current Department Name	New SBU	New Department Name	Change
—	Kaizen & Cost Reduction Department	—	Operations Kaizen Development Department	Name changed

## II. Personnel Changes

### 1. Senior Executive Officers (As of April 1)

#### Senior Executive Officers (Changed only (does not include organizational changes), 7 people)

Name	New Position	New Field in Charge	Current Position	Current Field in Charge
Tatsuya Watanuki <Promoted>*1	Executive Vice President, Division CEO	Assistant to President, Chief Officer Responsible for Japan Regional Strategy & Coordination, Lifestyle Division	Regional CEO	East Asia Region, President of Toyota Tsusho (China) Co., Ltd.
Hiroshi Tominaga	CSO, Regional CEO	Officer Responsible for Tokyo Head Office, Officer Responsible for Japan Regional Strategy & Coordination, Officer Responsible for Global Strategy and Management, Emerging Regions(Central & South America)	CSO, Regional CEO	Officer Responsible for Tokyo Head Office, Officer Responsible for Japan Regional Strategy & Coordination, Officer Responsible for Global Strategy and Management, Emerging Regions
Akihiro Sago	Division CEO	Circular Economy Division	Executive Vice President, Division CEO	Assistant to President, Chief Officer Responsible for Japan Regional Strategy & Coordination, Metals Division
Kosuke Kunihiro	Division CEO, Regional CEO	Green Infrastructure Division, Emerging Regions(Middle East & Central Asia)	Division CEO, Regional Officer	Machinery, Energy & Project Division, Emerging Regions
Akio Hamada	Regional CEO	East Asia Region President of Toyota Tsusho (China) Co., Ltd.	Division CEO	Chemicals & Electronics Division
Takashi Hirobe <Promoted>*2	Division CEO	Metal+(Plus) Division	Division COO	Metals Division Mobility Material SBU
Eiji Matsuzaki <Promoted>*2	Division CEO	Digital Solutions Division	Division COO	Chemicals & Electronics Division, Electronics SBU

CEO : Chief Executive Officer

CSO : Chief Strategy Officer

COO : Chief Operating Officer

\*1 Promotion to Executive Vice President

\*2 Promotion to Senior Executive Officer

## 2. Executive Officers (As of April 1)

### Executive Officers (Changed only (does not include organizational changes) , 13 people)

Name	New Position	New Field in Charge	Current Position	Current Field in Charge
Yasuhiro Kakiyama	Division COO, Company President	Digital Solutions Division Device & Software Solutions SBU President of NEXTY Electronics Corporation	Company President	President of NEXTY Electronics Corporation
Masaharu Katayama	Division COO	Circular Economy Division Resources Development SBU, Resources Recycling SBU	Division COO	Metals Division Non-ferrous Metals SBU, Resources Recycling SBU
Kohei Okada	Deputy CSO, Division COO, Regional Officer	External Affairs Department Africa Division, Africa Region	Deputy CSO	External Affairs Department
Hiroshi Yonenaga	Regional Officer	Emerging Regions(Middle East & Central Asia)	Division CEO	Food & Consumer Services Division
Kazuyuki Urata	Division COO	Circular Economy Division E-Mobility Supply Chain SBU	Division COO	Chemicals & Electronics Division Automotive Materials SBU
Hiroki Nakayama	Regional Officer, Company President	Asia Pacific Region, President of PT.Toyota Tsusho Indonesia	Regional Officer, Company President	Asia Pacific Region, President of Toyota Tsusho Asia Pacific Pte. Ltd.
Kazunori Sato	Division COO	Circular Economy Division Sustainable Materials SBU	Division COO	Chemicals & Electronics Division Chemicals SBU
Masato Ozaki	Division COO, Company President	Circular Economy Division, President of Toyotsu Chemiplas Corporation	Company President	President of Toyotsu Chemiplas Corporation
Takuro Akasaka	Division COO	Mobility Division Toyota SBU, Value Chain SBU	Division COO	Mobility Division Value Chain SBU

Name	New Position	New Field in Charge	Current Position	Current Field in Charge
Hiroshi Yanagisawa	Division COO	Metal+(Plus) Division Metal Solutions SBU	Division COO	Metals Division Metal Products SBU
Yuji Makino	Division COO	Green Infrastructure Division Machinery & Infrastructure SBU Branch Manager of Toyota Branch	Division COO	Machinery, Energy & Project Division Machinery SBU Branch Manager of Toyota Branch
Toshiyuki Ishikuro	Division COO	Green Infrastructure Division Green Energy SBU	Division COO	Machinery, Energy & Project Division Energy Infrastructure Solutions SBU
Zhao Junmin <New>	Regional Officer, Company President	Asia Pacific Region, President of Toyota Tsusho Asia Pacific Pte. Ltd.	General Manager	Global Parts & Logistics Division Global Parts SBU Global Parts Asia, Oceania & East Asia Regional Department

### 3. Retiring Senior Executive Officers / Executive Officers (On March 31)

#### Retiring Senior Executive Officer (1 people)

Name	Current Position
Akinori Saito	CSKO

CSKO : Chief Safety & KAIZEN Officer

#### Retiring Executive Officers (2 people)

Name	Current Position
Kazumasa Kimura	COO for Africa Division New Business Development, Regional Officer for Africa
Tetsuya Ezumi	COO for Mobility Division

## 4. General Managers et al. (as of April 1)

Changed only (does not include organizational changes), 62 people

### (1) Metal+(Plus) Division

New Organization	New Title	Name	Current Organization	Current Title
Metal+(Plus) Planning Department	General Manager	Hiroyuki Nakamura	Metal Planning Department	General Manager
Mobility Material Business Department	General Manager	Hideo Naruse	Mobility Material・GX Business Department	General Manager
Mobility Material Global Business Department	General Manager	Shinji Hattori	Business Transformation Acceleration Department	General Manager
Mobility Material Business Management Department	General Manager	Shinya Watanabe	Business Transformation Acceleration Department, GX Management Driving Group	—
Bar, Wire Rod & Pipe Products Business Department	General Manager	Yasuhiro Waki	Bar, Wire Rod & Pipe Products Department	General Manager
West-Japan Bar, Wire Rod & Pipe Products Business Department	General Manager	Shuji Takahashi	West-Japan Steel Products Department	General Manager

### (2) Circular Economy Division

New Organization	New Title	Name	Current Organization	Current Title
Circular Economy Planning Department	General Manager	Eiko Tajima	Chemicals & Electronics Planning Department	General Manager
Metal Resources Department	General Manager	Tsutomu Aoki	Prime Planet Energy & Solutions, Inc.	—
Mineral Resources & Inorganic Chemicals Department	General Manager	Keiju Akagishi	Resources Development Department	General Manager
Non-Ferrous Metals Business Department	General Manager	Satoru Ajioka	Non-Ferrous Metals Business Department	General Manager
Battery Supply Chain Business Department	General Manager	Makoto Iyoda	Next Mobility Chemical Materials Department	General Manager
Reverse Supply Chain Business Department	General Manager	Toshihiko Muroi	Circular Economy Business Acceleration Department	General Manager

New Organization	New Title	Name	Current Organization	Current Title
Aluminum Supply Chain Business Department	General Manager	Yasutomo Inuki	Non-Ferrous Material Recycling Business Department	General Manager
High Performance Materials Department	General Manager	Yasuhiro Fujii	Automotive Materials Project Development Department	General Manager
Sustainable Plastics Department	General Manager	Yoshichika Kanazawa	Sustainable Feedstocks and Plastics Department	General Manager
Consumer Products Business Department	General Manager	Hiroyuki Shio	Industrial Chemicals Department	General Manager
Essential Chemicals Department	General Manager	Kaname Takahashi	Organic Chemicals Strategy & Management Department	General Manager

### (3) Supply Chain Division

New Organization	New Title	Name	Current Organization	Current Title
Supply Chain Planning Department	General Manager	Koichi Enomoto	Global Parts & Logistics Department, Strategy Promotion Group	Manager
Supply Chain DX Department	General Manager	Koichiro Tanabe	Global Parts Business Management Department	General Manager
Global Parts Sales Department	General Manager	Ryo Sumiyoshi	Global Parts Sales Department, Customer Strategy Group	Manager
Global Parts Business Strategy Department	General Manager	Kim Miyoung	Toyota Tsusho Korea Corporation	—
Supply Chain Function Development Department	General Manager	Etsushi Sumino	SCM Functional Department	General Manager
Business Alliance Department	General Manager	Rikiya Iwase	Global Parts Sales Department	General Manager
Global Parts Export Department	General Manager	Kazutaka Nakamura	Global Parts America & Europe Regional Department	General Manager
Global Parts Import Department	General Manager	Takehiro Kosegaki	Toyota Tsusho (Thailand) Co., Ltd.	—

## (4) Mobility Division

New Organization	New Title	Name	Current Organization	Current Title
Oceania & Middle East Mobility Department	General Manager	Takeshi Abe	TTAS Company Ltd.	—
Asia & China Mobility Department	General Manager (Additional Post)	Takuro Akasaka	—	—
Multi Brands Business Department	General Manager	Masaaki Kawabata	Toyota Laos Co., Ltd	—

## (5) Green Infrastructure Division

New Organization	New Title	Name	Current Organization	Current Title
Green Infrastructure Planning Department	General Manager	Koji Katsumoto	Battery & Environment Machinery Department West-Japan Battery Production Machinery Group	Manager
Powertrain Machinery Department	General Manager	Mitsuru Yanase	Power & Drive Train Machinery Department	General Manager
EV Component Machinery Department	General Manager	Hidehisa Inoue	Battery & Environment Machinery Department	General Manager
Automotive Body Machinery Department	General Manager	Ryo Hayashi	Toyota Tsusho America, Inc.	—
Infrastructure Project Department	General Manager	Takao Tomita	Machinery, Energy & Project Planning Department	General Manager
Renewable Energy Strategy Department	General Manager	Raikoh Suzuki	Energy Solutions Development Department	General Manager
Carbon Neutral Fuels Department	General Manager	Toru Kobayashi	Carbon Neutral Fuels Department	—



## (6) Digital Solutions Division

New Organization	New Title	Name	Current Organization	Current Title
Digital Solutions Planning Department	General Manager	Yosuke Komatsu	Electronics Department	General Manager
Device Business Management Department	General Manager (Additional Post)	Yasuhiro Kakihara	—	—
Software Defined Vehicle Department	General Manager	Takamichi Kono	Software First Department	General Manager
Advanced Mobility Service Department	General Manager	Kazunori Mori	Smart Society Business Development Department	General Manager
Enterprise IT Department	General Manager	Takashi Matsuda	Information Technology Business Department	General Manager
Digital Infrastructure Department	General Manager	Eiji Yatabe	Electronics Department	—

## (7) Lifestyle Division

New Organization	New Title	Name	Current Organization	Current Title
Lifestyle Planning Department	General Manager	Masanori Shibata	Toyota Tsusho Insurance Management Corporation	President
Agribusiness Department	General Manager	Takuya Mori	Food Materials Department	General Manager
Food Materials Department	General Manager	Toshiaki Kainuma	Corporate Planning Department	—
Healthcare & Medical Department	General Manager	Kei Chijiwa	Healthcare & Medical Department Medical System Group	Manager

## (8) Africa Division

New Organization	New Title	Name	Current Organization	Current Title
Africa Power & Infrastructure Department	General Manager	Hiroumi Ohara	Africa Planning Department Power & Infrastructure Group	Manager

## (9) Administrative Unit

New Organization	New Title	Name	Current Organization	Current Title
Corporate Planning Department	General Manager	Kazutaka Kuromiya	PT.Toyota Tsusho Indonesia	President
External Affairs Department	General Manager	Fumiaki Nakanishi	Toyotsu Energy Corporation	President
Global Human Resources Department	General Manager	Rei Machinaga	Toyota Tsusho (Thailand) Co., Ltd.	—
Business Accounting Department	General Manager	Toyoji Yamasaki	Accounting Department, Consolidated Accounting Group	Manager
Finance Department	General Manager	Masashi Hirano	Corporate Planning Department, Strategic Planning Group	Manager
Investment & Credit Department	General Manager	Yuuichi Kiyooka	Power Project Planning & Asset Management Department	General Manage
Legal Department	General Manager	Hiroaki Mizuno	Toyota Tsusho (Thailand) Co., Ltd.	—
Global Safety & Environmental Promotion Department	General Manager	Katsumi Sampei	Global Safety & Environmental Promotion Department	—
Audit Department	General Manager	Akira Soga	Toyota Tsusho India Private Ltd.	—
Toyota Branch	Deputy General Manager (Additional Post)	Mitsuru Yanase	Power & Drive Train Machinery Department	General Manager

## (10) Asia Pacific

New Organization	New Title	Name	Current Organization	Current Title
Phnom Penh Liaison Office	General Manager	Atsushi Nomura	Borneo Technical (Thailand) Ltd.	President
Dhaka Liaison Office	General Manager	Yuji Wagata	Material Handling Machinery Department Solution Group	Manager

## ( 1 1 ) Emerging Regions

New Organization	New Title	Name	Current Organization	Current Title
Sociedade Comercial Toyota Tsusho Do Brasil Ltda.	President	Naoto Takahashi	Eastern Japan Global Parts Department	General Manager
Dubai Representative Office	General Manager	Tokuji Koyama	Energy Infrastructure Project Department	General Manager
Riyadh Liaison Office	General Manager	Tomohiro Iwakami	Power Project Development Department Power Project Development Group	Manager
Tashkent Liaison Office	General Manager	Hiroki Namikawa	External Affairs Department	General Manager

### III. Execution System (Senior Executive Officers) (As of April 1)

Position	Name	Field in Charge
President & CEO	Ichiro Kashitani	—
Executive Vice President, CTO, Regional CEO	Toshimitsu Imai	Assistant to President, Chief Officer Responsible for Tokyo Head Office, Chief Officer Responsible for Global Strategy and Management, Europe Region
Executive Vice President, Division CEO	Tatsuya Watanuki	Assistant to President, Chief Officer Responsible for Japan Regional Strategy & Coordination, Lifestyle Division
CSO, Regional CEO	Hiroshi Tominaga	Officer Responsible for Tokyo Head Office, Officer Responsible for Japan Regional Strategy & Coordination, Officer, Responsible for Global Strategy and Management, Emerging Regions(Central & South America)
CFO	Hideyuki Iwamoto	—
Division CEO	Akihiro Sago	Circular Economy Division
Division CEO, Regional CEO	Richard Bielle	Africa Division, Africa Region, Chairman & CEO of CFAO
Division CEO	Jun Eyama	Supply Chain Division
Regional CEO	Naoyuki Hata	North America Region President of Toyota Tsusho America, Inc.
Regional CEO	Shigeki Maeda	Asia Pacific Region, Asia Pacific, President of Toyota Tsusho (Thailand) Co., Ltd., President of Toyota Tsusho Thai Holdings Co.,Ltd.
Division CEO, Regional CEO	Kosuke Kunihiro	Green Infrastructure Division, Emerging Regions(Middle East & Central Asia)
Division CEO	Shigeru Harada	Mobility Division
Regional CEO	Akio Hamada	East Asia Region, President of Toyota Tsusho (China) Co., Ltd.
CHRO	Makiko Hamase	—
Division CEO	Takashi Hirobe	Metal+(Plus) Division
Division CEO	Eiji Matsuzaki	Digital Solutions Division

CTO : Chief Technology Officer

CFO : Chief Financial Officer

CHRO : Chief Human Resources Officer